

○ Avec ou sans mécanique  
With or without mechanical elements  
Con o senza parti meccaniche  
Mit oder ohne Aggregate  
Con ó sin mecanica desmontada

REP.	REFERENCE	PDS	NB	MZ
26	831.7026	2,1	1	080
27	831.7027	2,1	1	080
28	831.7028	0,2	2	
29	831.7029	1,0	4	
30	831.7030	2,1	1	602
31	831.7031	2,1	1	601
33	831.7033	1,9	1	140
34	831.7034	1,9	1	140
35	831.7035	1,9	1	260
36	831.7036	1,7	1	260
	CD.12	2,4	2	
	D.078	0,5	2	

	M 12-25 M 10x1,25-40 M 12x1,25-20 CHc 12-25 TB	6 1 4 4
	LLU 12	4

complément au  
complementary set to  
complemento al  
zusatz zu

**831.300**

**NISSAN**  
**831.309**

27 Kg	11.09.2000	410-D-63C
-------	------------	-----------

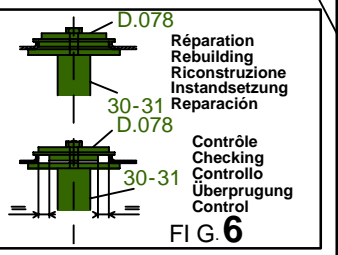
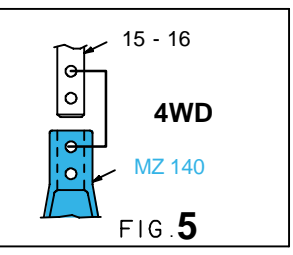
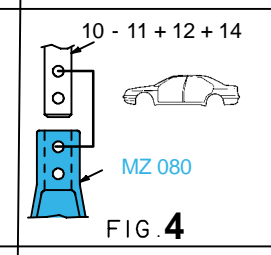
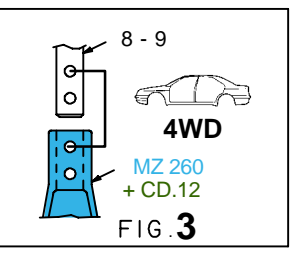
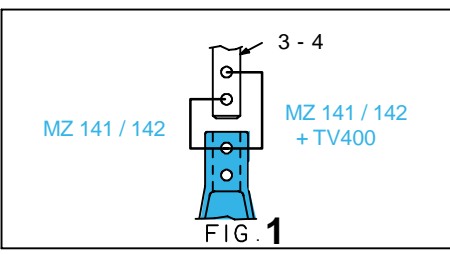
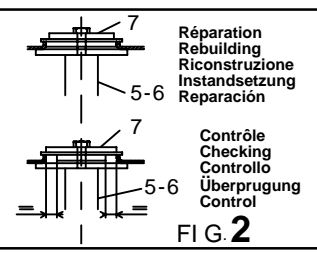
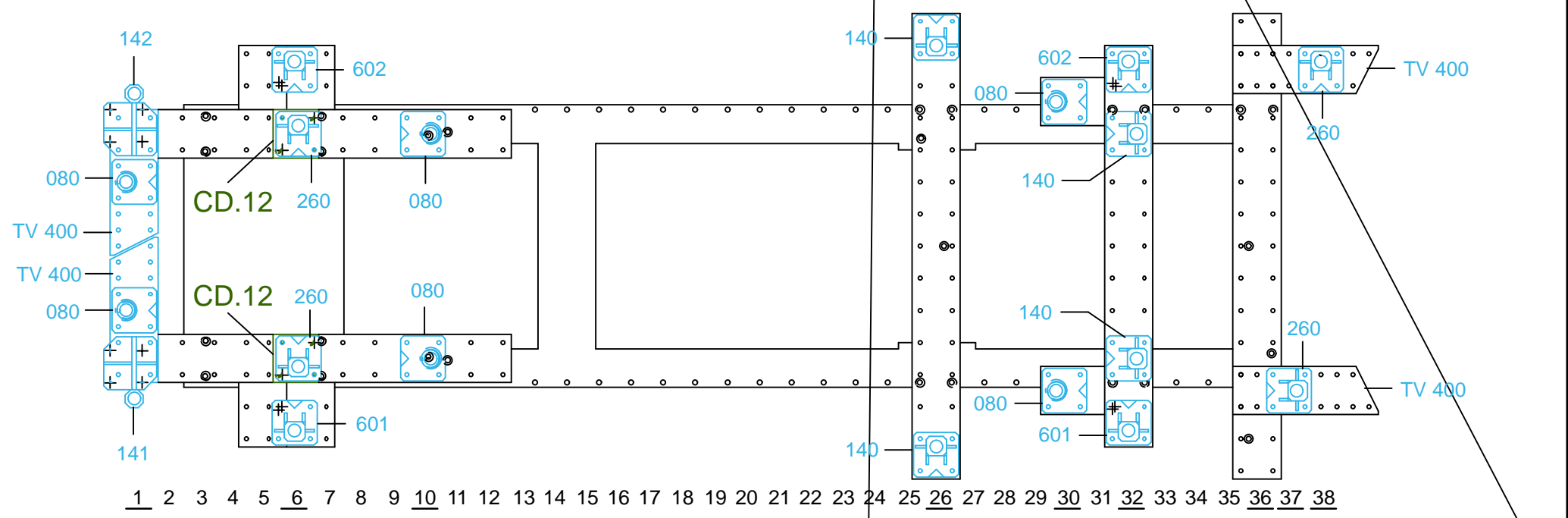

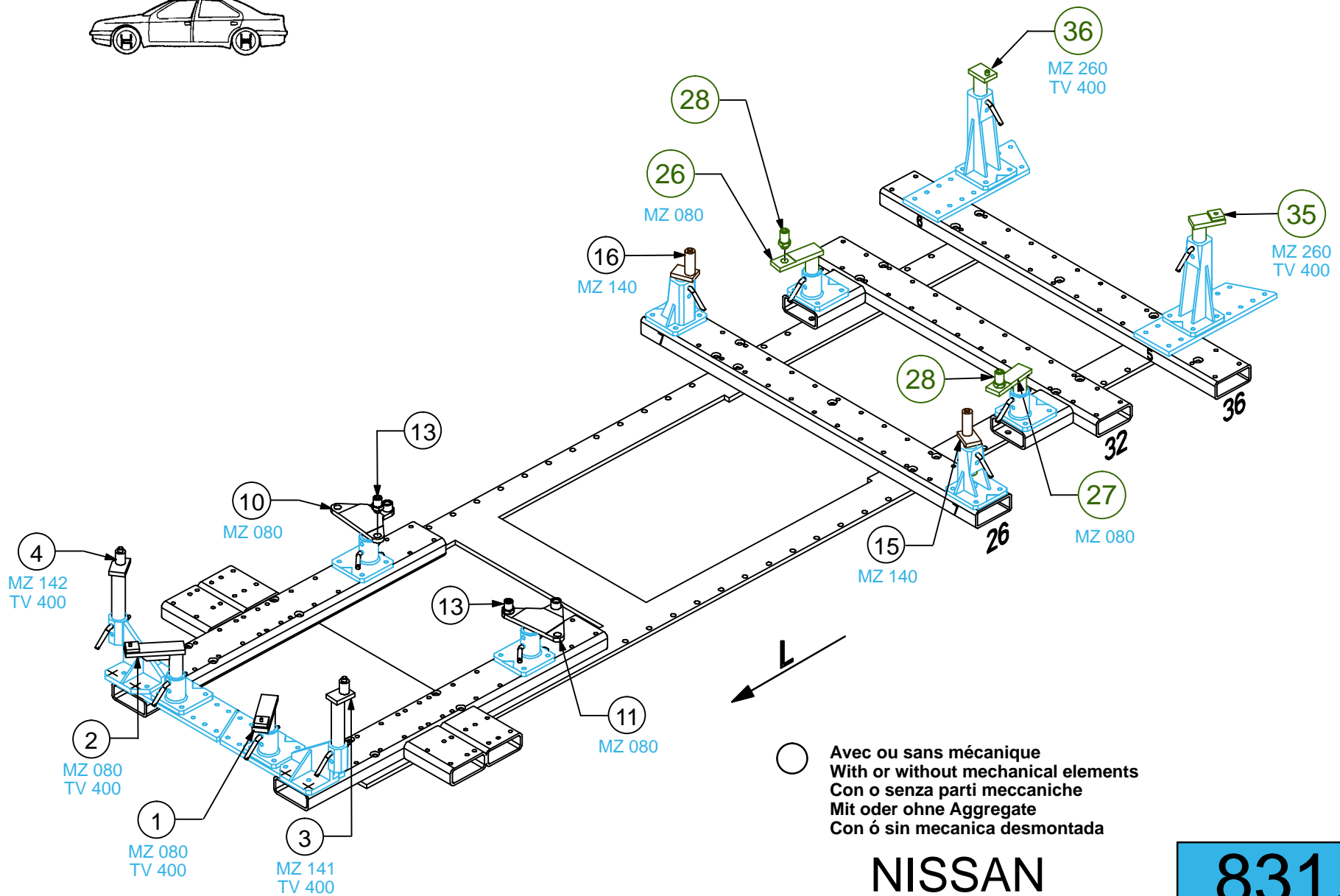
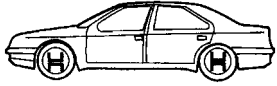

**NISSAN**

**831.309**

27 Kg | 11.09.2000 | 410-D-63D

