

REP.	REFERENCE	PDS	NB	MZ
1	2001.7001	2,9	1	140
2	2001.7002	2,9	1	140
3	2001.7003	8,4	1	
4	2001.7004	8,4	1	
7	2001.7007	8,5	2	
8	2001.7008	1,8	1	260
9	2001.7009	1,8	1	260
10	2001.7010	2,3	1	602
11	2001.7011	2,3	1	601
12	2001.7012	3,0	1	
13	2001.7013	3,0	1	
14	2001.7014	0,6	2	
15	2001.7015	1,8	1	080
16	2001.7016	1,8	1	080
17	2001.7017	14,1	1	
18	2001.7018	14,1	1	
19	2001.7019	0,3	2	
20	2001.7020	1,5	1	140
21	2001.7021	1,8	1	140
22	2001.7022	2,1	1	200
23	2001.7023	1,5	1	140
24	2001.7024	1,5	1	140
25	2001.7025	3,3	1	
26	2001.7026	3,3	1	
27	2001.7027	4,6	1	
28	2001.7028	4,6	1	
29	2001.7029	0,3	4	
30	2001.7030	1,8	1	140/080
31	2001.7031	1,8	1	140/080
32	2001.7032	4,6	1	260
33	2001.7033	4,6	1	260
34	2001.7034	3,6	1	141
35	2001.7035	3,6	1	142
36	2001.7036	2,8	1	200
37	2001.7037	5,2	1	200
38	2001.7038	3,1	1	
39	2001.7039	2,6	1	
40	2001.7040	0,15	4	
41	2001.7041	0,03	6	
42	2001.7042	2,8	1	
43	2001.7043	2,8	1	
45	2001.7045	0,06	2	
47	2001.7047	2,8	1	200/140
48	2001.7048	2,8	1	200/140

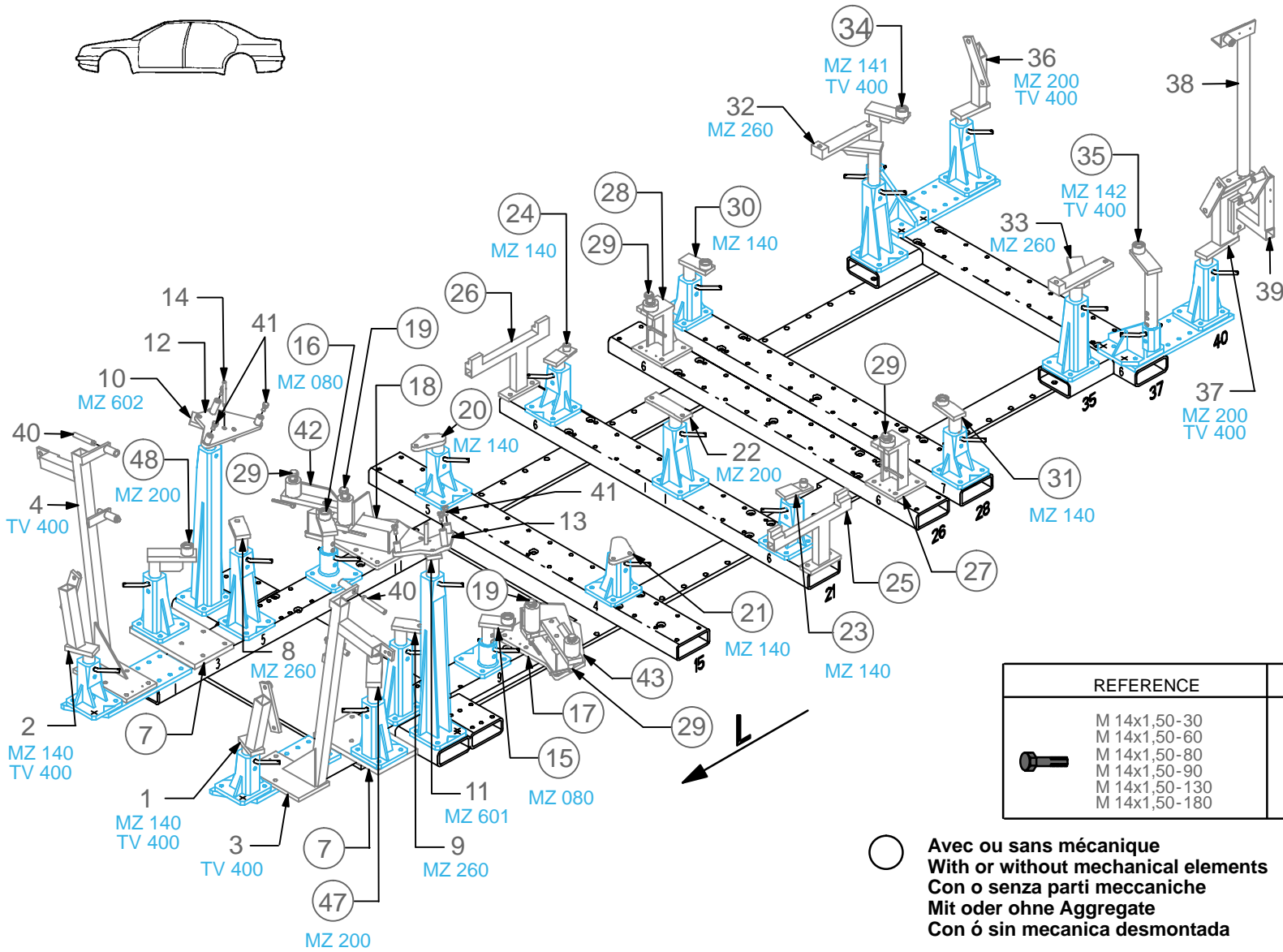

REFERENCE	NB
M 14x1,50-30	4
M 14x1,50-60	2
M 14x1,50-80	6
M 14x1,50-90	2
M 14x1,50-130	6
M 14x1,50-180	2

○ Avec ou sans mécanique
 With or without mechanical elements
 Con o senza parti meccaniche
 Mit oder ohne Aggregate
 Con ó sin mecanica desmontada

955751	8
M 6-20	2
M 8-70	2
M 10-25	6
M 10-30	2
M 10-35	8
M 10-50	1
M 12-25	8
M 12-30	4
M 12-35	4
M 12x1,50-50	2
M 12x1,50-70	2
LU 10	1
M 10	1

PORSCHE

2001.330

163 Kg | 02.02.2004 | 425-D-6C

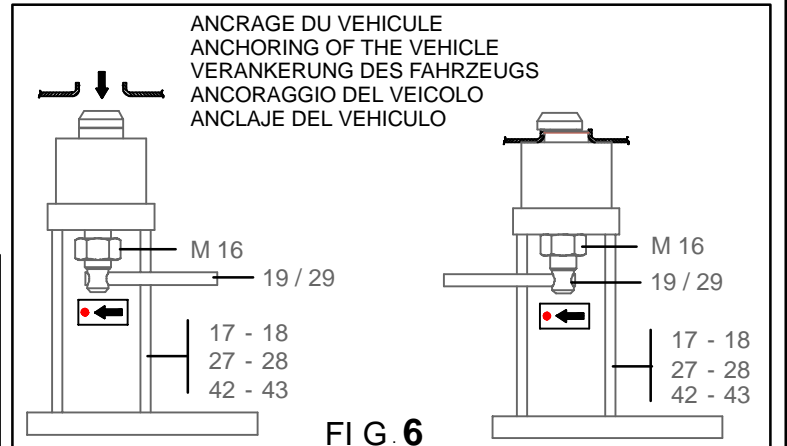
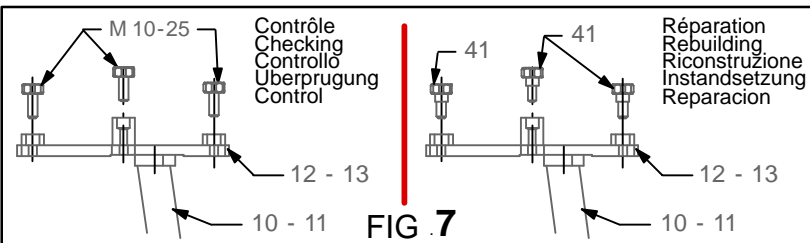
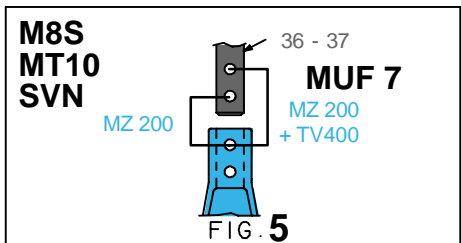
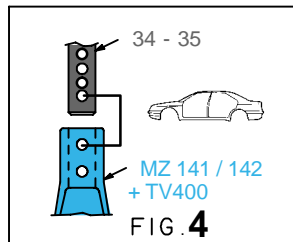
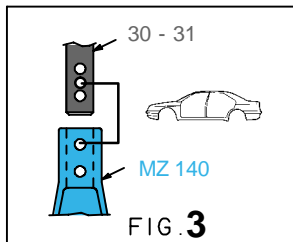
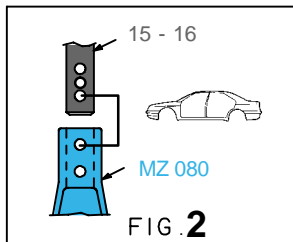
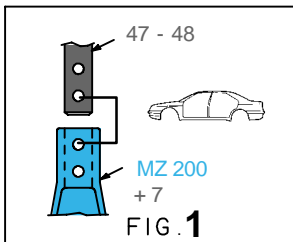
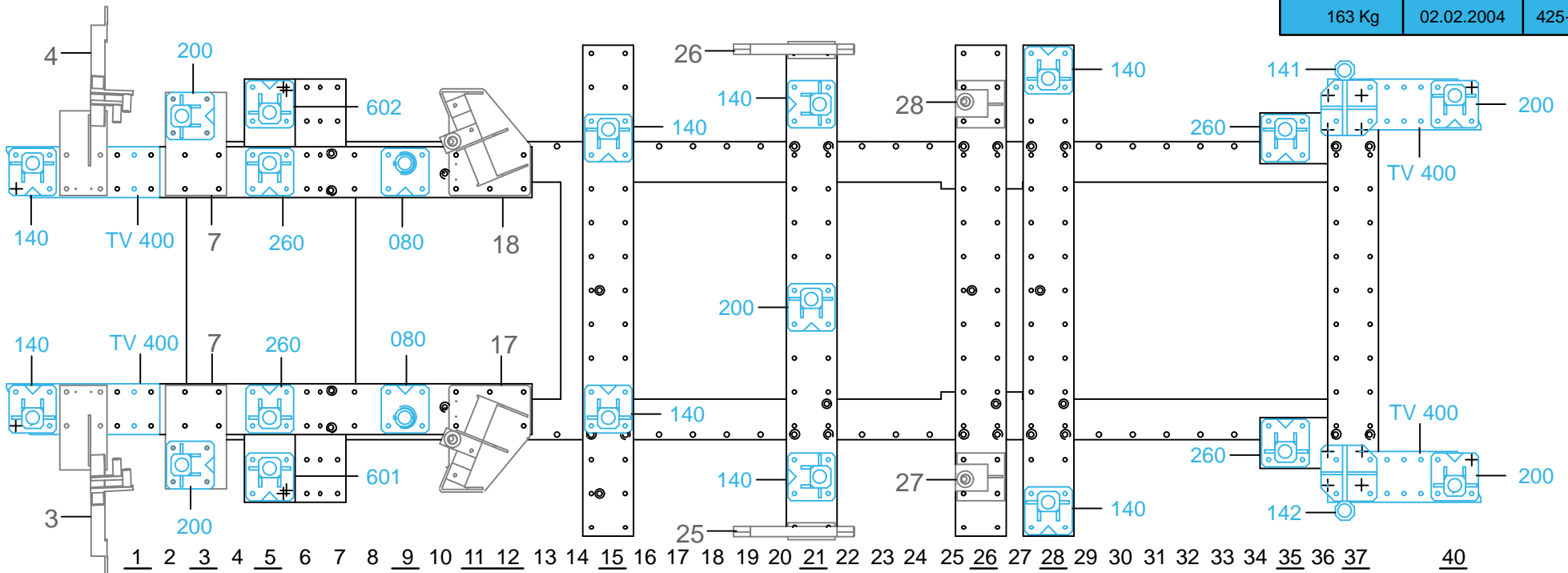

2001.330-RVA3-1 | 00

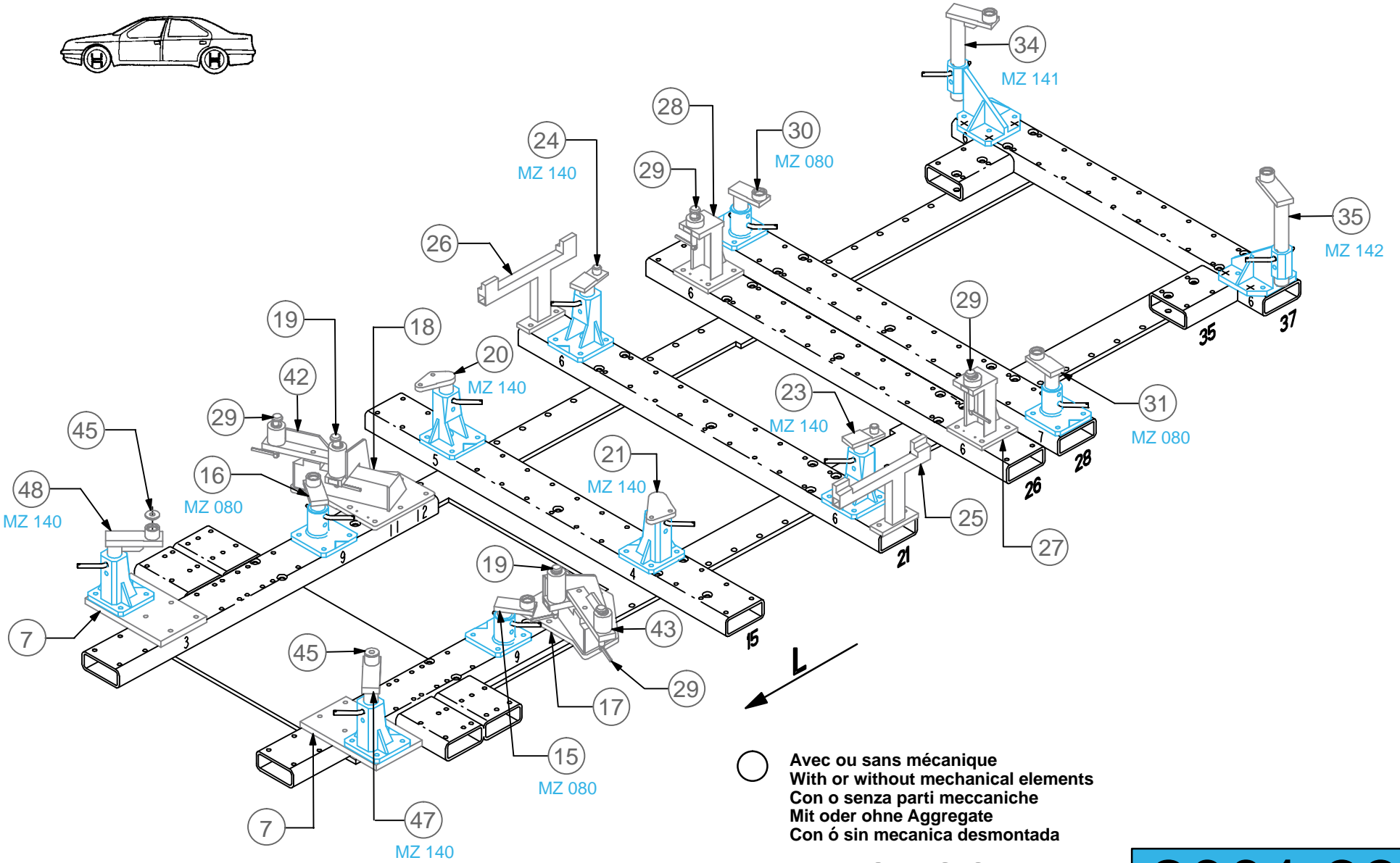
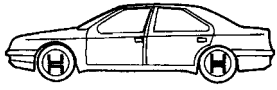

PORSCHE

2001.330

163 Kg	02.02.2004	425-D-6D
--------	------------	----------

